

Chip Beads(SMD) For Power Line

Conformity to RoHS Directive

MPZ Series MPZ1608 Type

FEATURES

- This type is the best for energy-saving in the low DC resistance.
- The products contain no lead and also support lead-free soldering.
- It is a product conforming to RoHS directive.

APPLICATIONS

Noise suppression of personal computers, USB/IEEE1394 interfaces, HDDs, CD-ROMs, DVDs, DSCs, LCD panels, cellular phones, etc.

PRODUCT IDENTIFICATION

| MPZ | 1608 | S | 221 | A | T |
|-----|------|-----|-----|-----|-----|
| (1) | (2) | (3) | (4) | (5) | (6) |

- (1) Series name
 (2) Dimensions L×W
 (3) Material code
 (4) Nominal impedance
 221: 220Ω at 100MHz
 (5) Characteristic type
 (6) Packaging style
 T: Taping

HANDLING AND PRECAUTIONS

- Before soldering, be sure to preheat components. The preheating temperature should be set so that the temperature difference between the solder temperature and product temperature does not exceed 150°C.
- After mounting components onto the printed circuit board, do not apply stress through board bending or mishandling.
- Do not expose the inductors to stray magnetic fields.
- Avoid static electricity discharge during handling.
- When hand soldering, apply the soldering iron to the printed circuit board only. Temperature of the iron tip should not exceed 350°C. Soldering time should not exceed 3 seconds.

MATERIAL CHARACTERISTICS

- R material:** For wide frequency applications calling for broad impedance characteristics.
 For digital signal line applications calling requiring good waveform integrity. Impedance values selected for effectiveness at 10 to 200MHz.
- S material:** Standard type that features impedance characteristics similar to those of a typical ferrite core.
 For signal line applications in which the blocking region is near 100MHz. Impedance values selected for effectiveness at 40 to 300MHz.
- Y material:** High frequency range type intended for the 100MHz region and above.
 For signal line applications in which the signal frequency is far from the cutoff frequency. Impedance values selected for effectiveness at 80 to 400MHz.
- D material:** For applications calling for low insertion loss at low frequencies and sharply increasing impedance at high frequencies. Designed for high impedance at high frequencies (300MHz to 1GHz) for signal line applications.

TYPICAL MATERIAL CHARACTERISTICS

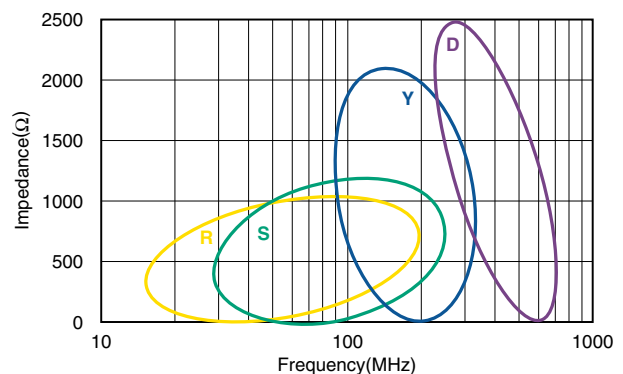

- Conformity to RoHS Directive: This means that, in conformity with EU Directive 2002/95/EC, lead, cadmium, mercury, hexavalent chromium, and specific bromine-based flame retardants, PBB and PBDE, have not been used, except for exempted applications.

- Please contact our Sales office when your application are considered the following:
 The device's failure or malfunction may directly endanger human life (e.g. application for automobile/aircraft/medical/nuclear power devices, etc.)

- All specifications are subject to change without notice.

SHAPES AND DIMENSIONS/RECOMMENDED PC BOARD PATTERN

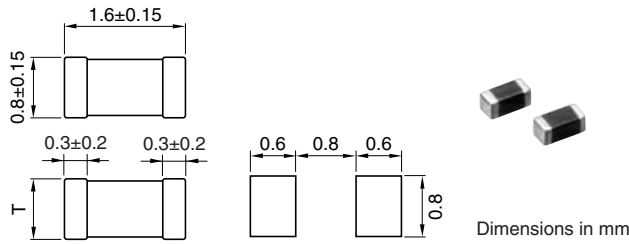

| Thickness(T) | Weight |
|--------------|--------|
| 0.6±0.15mm | 3mg |
| 0.8±0.15mm | 4mg |

TEMPERATURE RANGES

Operating/storage -55 to +125°C

PACKAGING STYLE AND QUANTITIES

| Packaging style | Quantity |
|-----------------|------------------|
| Taping | 4000 pieces/reel |

RECOMMENDED SOLDERING CONDITION REFLOW SOLDERING

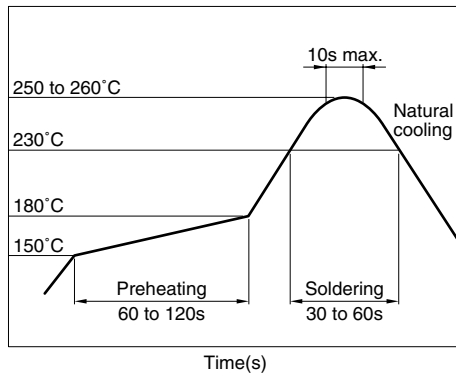

ELECTRICAL CHARACTERISTICS

| Part No. | Impedance (Ω)[100MHz] ^{*1} | DC resistance (Ω)max. | Rated current ^{*2} (A)max. | Thickness T(mm) |
|--------------|---|-----------------------------------|--|--------------------|
| MPZ1608S300A | 30±10 Ω | 0.01 | 5 | 0.6 |
| MPZ1608S600A | 60±25% | 0.02 | 3.5 | 0.6 |
| MPZ1608S101A | 100±25% | 0.03 | 3 | 0.6 |
| MPZ1608S221A | 220±25% | 0.05 | 2 | 0.8 |
| MPZ1608S331A | 330±25% | 0.08 | 1.5 | 0.8 |
| MPZ1608R391A | 390±25% | 0.12 | 1.2 | 0.8 |
| MPZ1608S601A | 600±25% | 0.15 | 1 | 0.8 |
| MPZ1608Y600B | 60±25% | 0.03 | 2.3 | 0.8 |
| MPZ1608Y101B | 100±25% | 0.04 | 2 | 0.8 |
| MPZ1608Y151B | 150±25% | 0.05 | 1.8 | 0.8 |
| MPZ1608D300B | 30±10 Ω | 0.06 | 1.8 | 0.8 |
| MPZ1608D600B | 60±25% | 0.1 | 1.2 | 0.8 |
| MPZ1608D101B | 100±25% | 0.15 | 1 | 0.8 |

*1 Test equipment: E4991A or equivalent

Test tool: 16192A or equivalent

Test temperature: 25±10°C

*2 Please refer to the graph of RATED CURRENT vs. TEMPERATURE CHARACTERISTICS(DERATING) about the rating current at 85°C or more in temperature of the product.

RATED CURRENT vs. TEMPERATURE CHARACTERISTICS (DERATING)

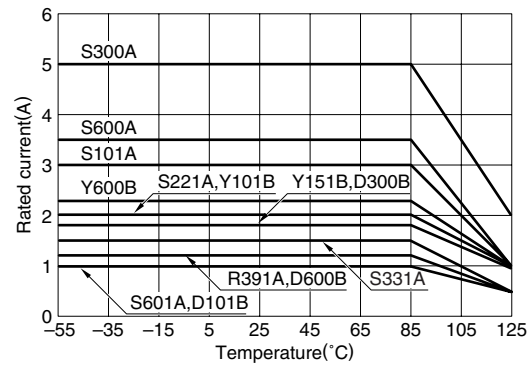

TYPICAL ELECTRICAL CHARACTERISTICS

Z, X, R vs. FREQUENCY CHARACTERISTICS

MPZ1608S300A

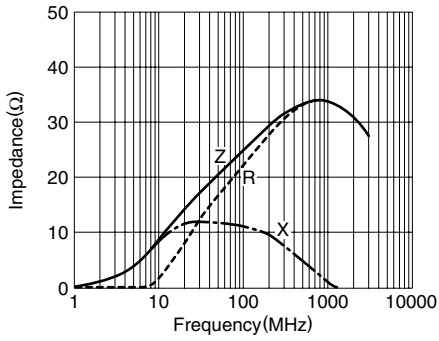

MPZ1608S600A

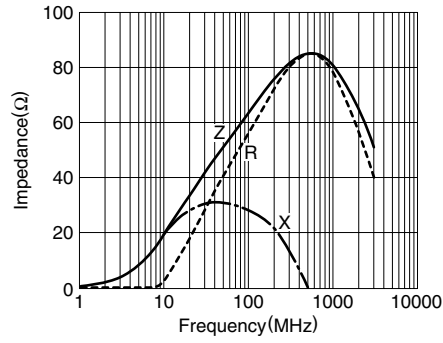

MPZ1608S101A

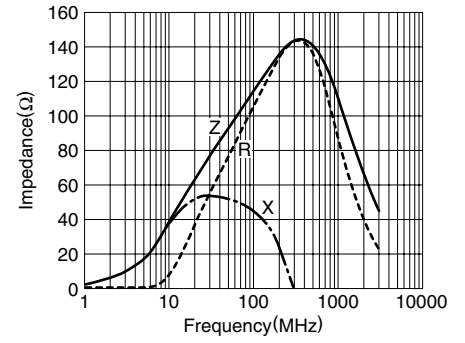

MPZ1608S221A

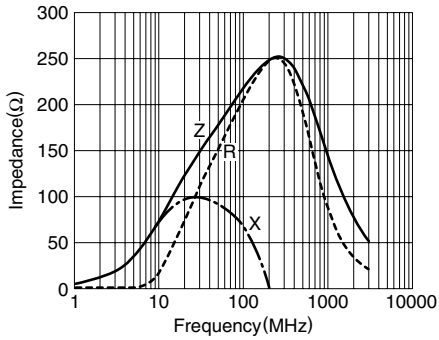

MPZ1608S331A

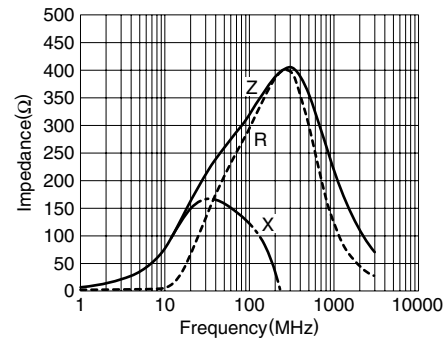

MPZ1608R391A

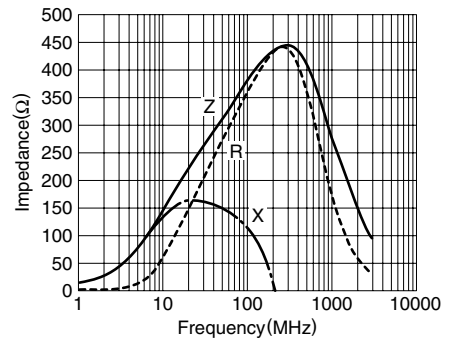

MPZ1608S601A

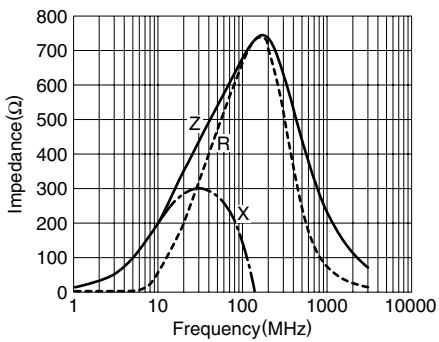

• All specifications are subject to change without notice.

TYPICAL ELECTRICAL CHARACTERISTICS

Z, X, R vs. FREQUENCY CHARACTERISTICS

MPZ1608Y600B

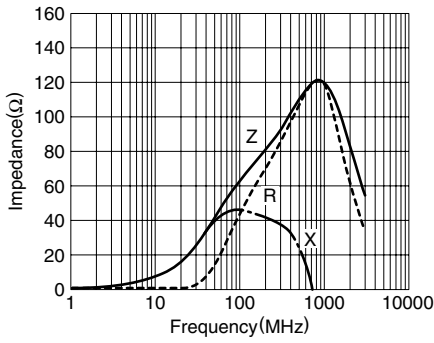

MPZ1608Y101B

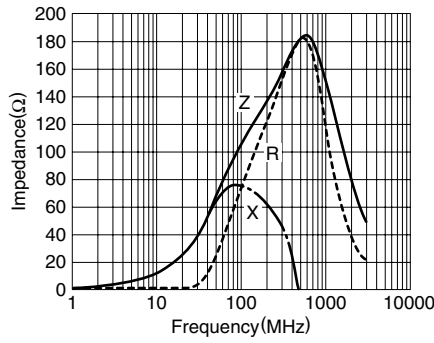

MPZ1608Y151B

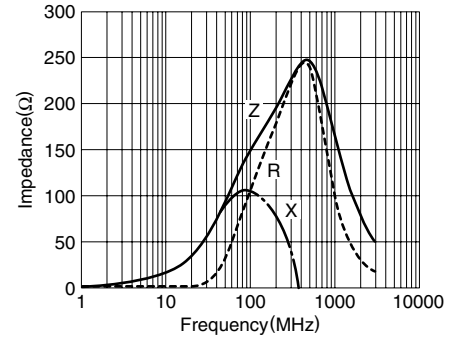

MPZ1608D300B

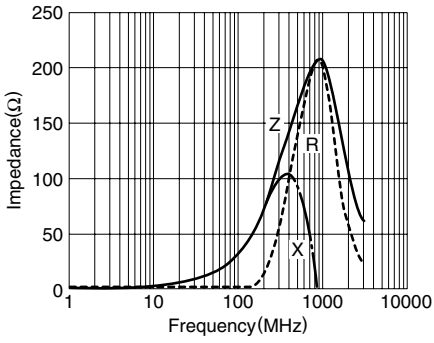

MPZ1608D600B

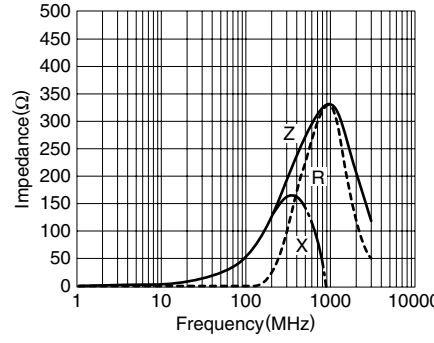

MPZ1608D101B

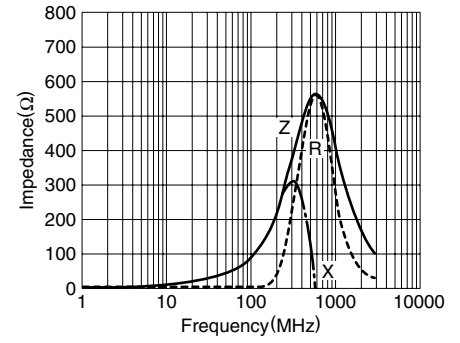

PACKAGING STYLES

REEL DIMENSIONS

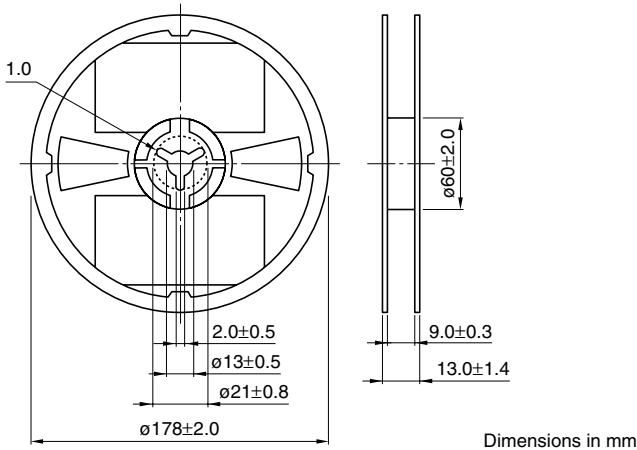

Dimensions in mm

TAPE DIMENSIONS

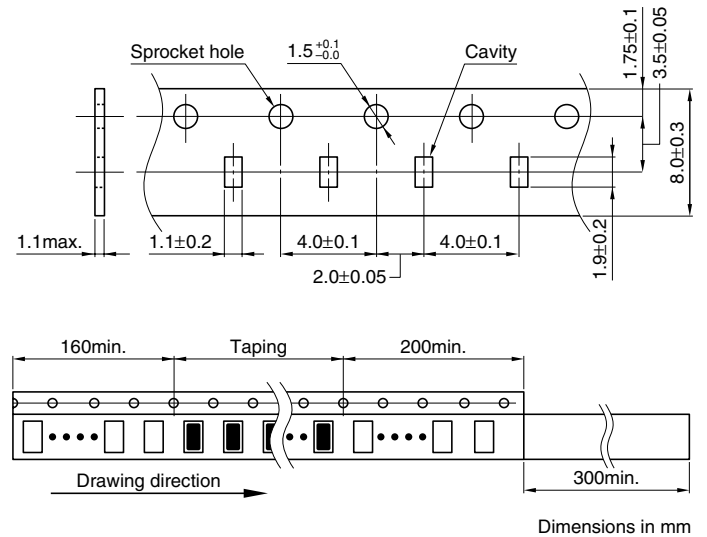

Dimensions in mm

• All specifications are subject to change without notice.